

Technical Datasheet - Metal Trim

Chrome Plated Aluminium - TDP / ESA / LFA

Product Description

These Premium sections offer a more luxurious finish to any edge.

Perfect for Wall edges or feature strips to create timeless elegance for those creative designs.

Dimensions and Colour

TDP profiles are available in 2.5m lengths in 10mm and 12mm depths.

LFA profiles are available in 2.5m lengths and 10mm widths.

ESA profiles are available in 2.5m lengths in 8mm, 10mm, 12mm depths.



Range

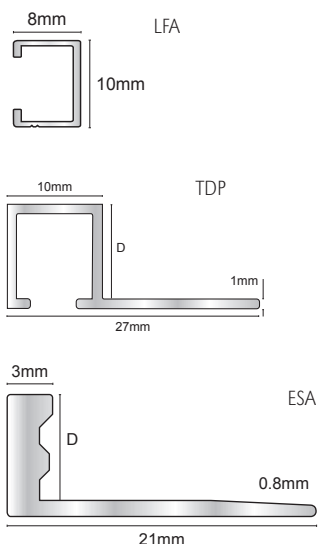

Technical Details

Chrome plated to an overall thickness of 80 microns with protective film to be removed after grouting.

Allied Products:

TDP has specially designed aluminium corner pieces EDP. They provide perfect corners with no sharp edges where mitering of the profile is required. Available in 10mm and 12mm depths.

Maintenance

Chrome Plated is designed for a High Chrome finish specifically on Wall Tile installations, although it can be used on the floor the Chrome plating is a decorative finish and we recommend you protect it from abrasives that could scratch the seen surface of the profile.

Do not use products containing hydrochloric or hydrofluoric acid.
Cleaning products must not be abrasive.
Use neutral cleaning products. Profiles can easily be cleaned using clean water with a few drops of washing up liquid.
No cleaning agents containing solvents may be used. We recommend first selecting an inconspicuous area to verify its suitability. Aluminium must be tested to verify its suitability if chemical stresses are anticipated.

Cementitious materials, in conjunction with moisture, become alkaline. Since aluminium is sensitive to alkaline substances, exposure to the alkali (depending on the concentration and time of exposure) may result in corrosion (aluminium hydroxide formation). Therefore, it is important to remove adhesive or grout residue from visible surfaces. In addition, ensure that the profile is solidly embedded in the setting material and that all cavities are filled to prevent the collection of alkaline water.

Therefore, setting materials must be removed immediately. Otherwise, the description regarding aluminium applies.

Installation

1. Select profile according to tile thickness.
2. Ensure the protective film is still in place and cut to desired length using a fine tooth blade. We recommend Genesis Art No. 919PHS.
3. Trowel tile adhesive over the area that forms the perimeter of the tiled covering.
4. Press the TDP / ESA perforated anchoring leg of the profile into the tile adhesive and align, mechanical fix if required.

Press the LFA profile into place and align on top of the already laid tile.
5. Trowel additional adhesive over the perforated anchoring leg to ensure full coverage.
6. Solidly embed the tiles so that the tiled surface is flush with the top of the profile, the profile should not be higher than the tiled surface.
7. Fill the joint completely with grout.

Aluminium AA 6063 T6 / UNS A96063 anodised to DIN 17611

Si%	0.2-0.6
Fe%	0.35
Cu%	0.1
Mn%	0.1
Mg%	0.45-0.9
Zn%	0.1
Ti%	0.1
Cr%	0.1
Al	Balance

P.V.C. Trim • Stair Nosings • Movement Joints • Transitions • Entrance Matting • Edge Protection • Metal Profiles • Tactiles • Tools

Tel: +44 (0)1642 713000

Email: info@genesis-gs.com

www.genesis-gs.com

UK Head Office
Stokesley Business Park Stokesley
North Yorkshire TS9 5JZ UK



Genesis
For the Perfect Finish



Technical Datasheet - Metal Trim

Aluminium Chrome Plated - TDP

How to cut Aluminium Chrome Plated profiles without damaging or chipping the surface

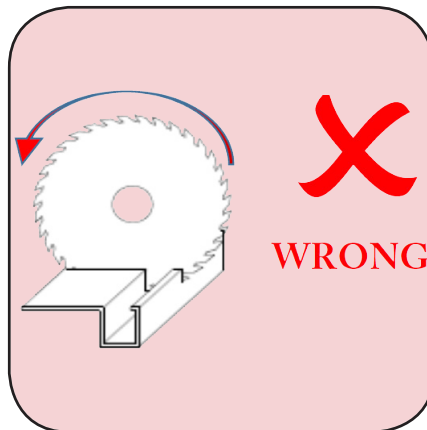
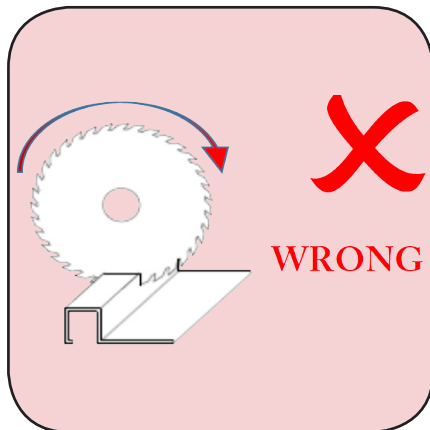
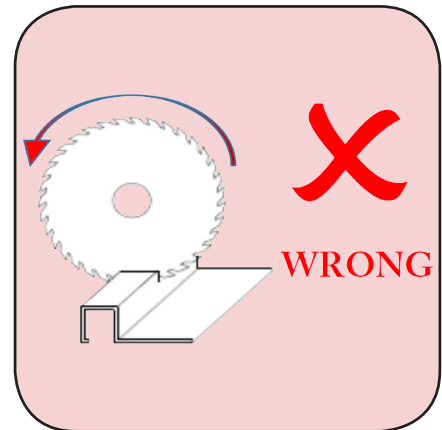
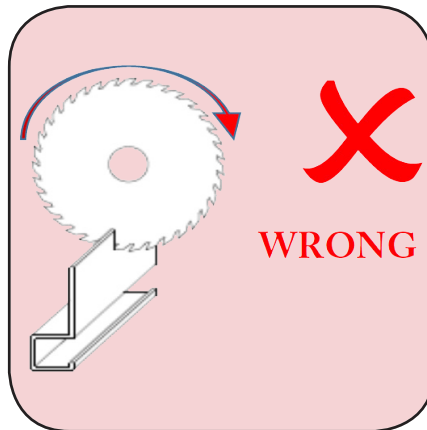
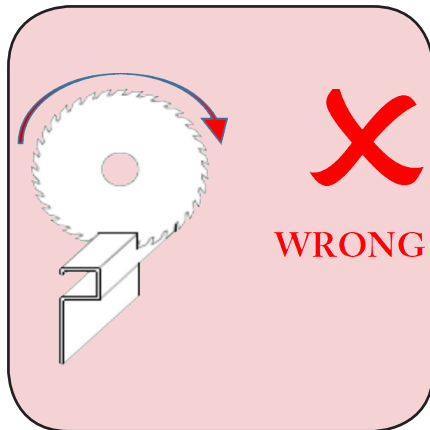
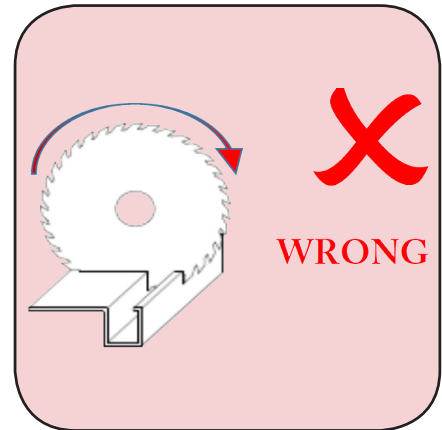
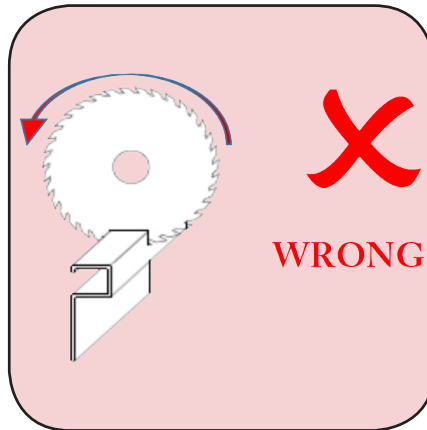
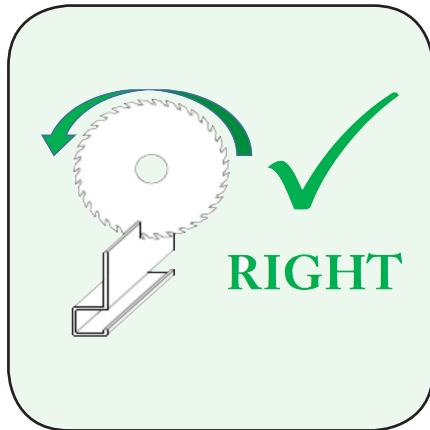

P.V.C. Trim • Stair Nosings • Expansion Joints • Transitions • Seals • Edge Protection • Metal Trim • Skirting • Tools

Tel: +44 (0)1642 713000
Email: info@genesis-gs.com

www.genesis-gs.com

UK Head Office
Stokesley Business Park Stokesley
North Yorkshire TS9 5JZ UK



Genesis
For the Perfect Finish

